

Cree® CLN6A-WKW/MKW

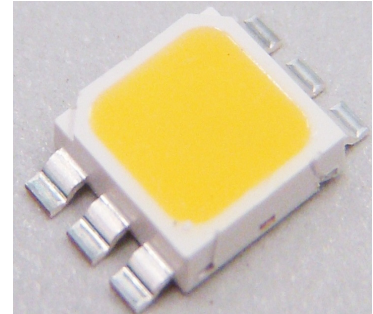

PRODUCT DESCRIPTION

The CLN6A LED delivers superior value with common voltage, current, size and optical properties. The Cree CLN6A is available in both cool and warm white to address a variety of lighting applications, including linear, portable, landscape and entertainment.

FEATURES

- Size (mm): 5.0 x 5.0 x 1.3
- Color Temperatures(K):
Cool White :
Min . (4600) / Typical (5500)
Warm White :
Min . (2500) / Typical (3200)
- Luminous Intensity (mcd)
CLN6A-WKW:
(60.5 - 101.8)
CLN6A-MKW:
(51.0 - 101.8)
- CRI
Typical CRI for Cool White is 72
Typical CRI for Warm White is 80
- Viewing angle: 115 degree
- Lead-Free
- RoHS Compliant

APPLICATIONS

- Light Strip
- Channel Letter
- Backlight

ABSOLUTE MAXIMUM RATINGS ($T_A = 25^\circ\text{C}$)

Items	Symbol	Absolute Maximum Rating	Unit
		Cool/Warm	
Forward Current	I_F	350	mA
Peak Forward Current ^{Note1}	I_{FP}	600	mA
Reverse Voltage	V_R	5	V
Power Dissipation	P_D	1200	mW
Operation Temperature	T_{opr}	-40 ~ +90	$^\circ\text{C}$
Storage Temperature	T_{stg}	-40 ~ +100	$^\circ\text{C}$
Junction Temperature	T_J	125	$^\circ\text{C}$

Note: Pulse width ≤ 0.1 msec, duty $\leq 1/10$.

TYPICAL ELECTRICAL & OPTICAL CHARACTERISTICS ($T_A = 25^\circ\text{C}$)

Characteristics	Color	Symbol	Condition	Unit	Minimum	Typical	Maximum
Forward Voltage	Cool/Warm	V_F	$I_F = 300$ mA	V		3.8	4.4
Reverse Current	Cool/Warm	I_R	$V_R = 5$ V	μA			100
Luminous Flux	Cool	Φ_v	$I_F = 300$ mA	lm	60.5	80	
	Warm	Φ_v	$I_F = 300$ mA	lm	51.0	72	
Chromaticity Coordinates	Cool	x	$I_F = 300$ mA			0.3325	
		y	$I_F = 300$ mA			0.3411	
	Warm	x	$I_F = 300$ mA			0.4234	
		y	$I_F = 300$ mA			0.3990	
Thermal Resistance, Junction to solder Point ^{Note1}	Cool/Warm	R_{THJS}	$I_F = 300$ mA	$^\circ\text{C}/\text{W}$		15	
50% Power Angle(FWHM)	Cool/Warm	$2\theta_{1/2}$	$I_F = 300$ mA	deg		115	

Note: Rth test condition: mounted on MCPCB (pad size ≥ 40 mm²).

INTENSITY BIN LIMIT ($I_f = 300 \text{ mA}$)

Cool White (CLN6A-WKW)

Bin Code	Min.(lm)	Max.(lm)
J0	60.5	72.0
K0	72.0	85.6
L0	85.6	101.8

Warm White (CLN6A-MKW)

Bin Code	Min.(lm)	Max.(lm)
H0	51.0	60.5
J0	60.5	72.0
K0	72.0	85.6
L0	85.6	101.8

Tolerance of measurement of luminous intensity is $\pm 10\%$.

VF BIN LIMIT ($I_f = 300 \text{ mA}$)

Cool White (CLN6A-WKW)

Bin Code	Min.(V)	Max.(V)
44	2.8	3.2
45	3.2	3.6
46	3.6	4.0
47	4.0	4.4

Warm White (CLN6A-MKW)

Bin Code	Min.(V)	Max.(V)
44	2.8	3.2
45	3.2	3.6
46	3.6	4.0
47	4.0	4.4

Tolerance of measurement of VF is $\pm 0.05\text{V}$.

COLOR BIN LIMIT ($I_f = 300 \text{ mA}$)

Cool White

Bin Code	Sub-bin	x	y
W1	Wa	0.2545	0.2480
		0.2633	0.2410
		0.2545	0.2245
		0.2450	0.2290
	Wb	0.2633	0.2410
		0.2720	0.2340
		0.2640	0.2200
		0.2545	0.2245
	Wc	0.2545	0.2480
		0.2640	0.2670
		0.2720	0.2575
		0.2633	0.2410
	Wd	0.2633	0.2410
		0.2720	0.2575
		0.2800	0.2480
		0.2720	0.2340
W2	We	0.2640	0.2670
		0.2735	0.2860
		0.2808	0.2740
		0.2720	0.2575
	Wf	0.2720	0.2575
		0.2808	0.2740
		0.2880	0.2620
		0.2800	0.2480
	Wg	0.2735	0.2860
		0.2830	0.3050
		0.2895	0.2905
		0.2808	0.2740
	Wh	0.2808	0.2740
		0.2895	0.2905
		0.2960	0.2760
		0.2880	0.2620

Bin Code	Sub-bin	x	y
W3	Wj	0.2830	0.3050
		0.2950	0.3210
		0.2998	0.3028
		0.2895	0.2905
	Wk	0.2895	0.2905
		0.2998	0.3028
		0.3045	0.2865
		0.2960	0.2760
	Wm	0.2950	0.3210
		0.3070	0.3370
		0.3100	0.3150
		0.2998	0.3028
	Wn	0.2998	0.3028
		0.3100	0.3150
		0.3130	0.2970
		0.3045	0.2865
W4	Wp	0.3070	0.3370
		0.3185	0.3485
		0.3200	0.3270
		0.3100	0.3150
	Wq	0.3100	0.3150
		0.3200	0.3270
		0.3215	0.3075
		0.3130	0.2970
	Wr	0.3185	0.3485
		0.3300	0.3600
		0.3300	0.3390
		0.3200	0.3270
	Ws	0.3200	0.3270
		0.3300	0.3390
		0.3300	0.3180
		0.3215	0.3075

Bin Code	Sub-bin	x	y
W5	Wt	0.3300	0.3600
		0.3455	0.3725
		0.3443	0.3535
		0.3300	0.3390
	Wu	0.3300	0.3390
		0.3443	0.3535
		0.3430	0.3345
		0.3300	0.3180
	Wv	0.3455	0.3725
		0.3610	0.3850
		0.3585	0.3680
		0.3443	0.3535
	Ww	0.3443	0.3535
		0.3585	0.3680
		0.3560	0.3510
		0.3430	0.3345

Tolerance of measurement of the color coordinates is ± 0.01 .

COLOR BIN LIMIT ($I_f = 300 \text{ mA}$)

Warm White

Bin Code	Sub-bin	x	y
M1	Ma	0.3610	0.3900
		0.3576	0.3651
		0.3751	0.3783
		0.3820	0.4075
	Mb	0.3576	0.3651
		0.3541	0.3401
		0.3682	0.3491
		0.3749	0.3781
	Mc	0.3820	0.4075
		0.3751	0.3783
		0.3926	0.3915
		0.4030	0.4250
	Md	0.3751	0.3783
		0.3682	0.3491
		0.3822	0.3580
		0.3926	0.3915

Bin Code	Sub-bin	x	y
M2	Me	0.4030	0.4250
		0.3926	0.3915
		0.4118	0.4021
		0.4260	0.4390
	Mf	0.3926	0.3915
		0.3822	0.3580
		0.3976	0.3653
		0.4118	0.4021
	Mg	0.4260	0.4390
		0.4118	0.4021
		0.4310	0.4128
		0.4490	0.4530
	Mh	0.4118	0.4021
		0.3976	0.3653
		0.4129	0.3725
		0.4310	0.4128

Bin Code	Sub-bin	x	y
M3	Mj	0.4490	0.4530
		0.4310	0.4128
		0.4572	0.4203
		0.4785	0.4625
	Mk	0.4310	0.4128
		0.4129	0.3726
		0.4359	0.3782
		0.4572	0.4203
	Mm	0.4785	0.4625
		0.4572	0.4203
		0.4834	0.4279
		0.5080	0.4720
	Mn	0.4572	0.4203
		0.4359	0.3782
		0.4588	0.3838
		0.4834	0.4279

Tolerance of measurement of the color coordinates is ± 0.01 .

CIE CHROMATICITY DIAGRAM

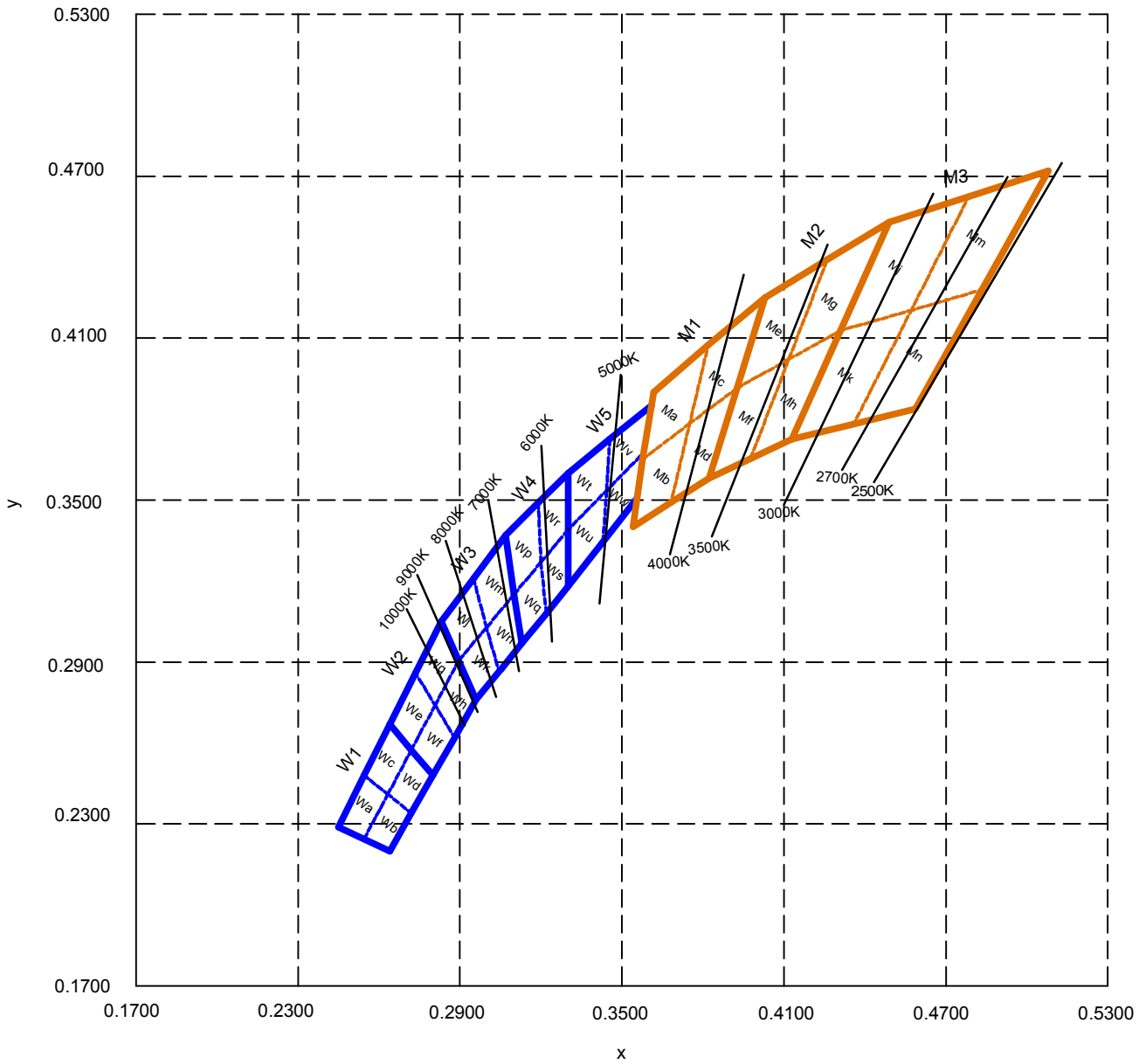

ORDER CODE TABLE*

Color	Kit Number	Viewing Angle	Luminous Flux (lm)		Color Bin Code
			Min.	Max.	
Cool White	CLN6A-WKW-CJ0L0153	115	60.5	101.8	W1,W2,W3,W4,W5
Cool White	CLN6A-WKW-CJ0L0343	115	60.5	101.8	W3,W4
Cool White	CLN6A-WKW-CJ0L0453	115	60.5	101.8	W4,W5
Cool White	CLN6A-WKW-CK0L0343	115	72.0	101.8	W3,W4
Cool White	CLN6A-WKW-CK0L0453	115	72.0	101.8	W4,W5

Color	Kit Number	Viewing Angle	Luminous Flux (lm)		Color Bin Code
			Min.	Max.	
Warm White	CLN6A-MKW-CH0K0133	115	51.0	85.6	M1,M2,M3
Warm White	CLN6A-MKW-CH0K0233	115	51.0	85.6	M2,M3
Warm White	CLN6A-MKW-CH0K0513	115	51.0	85.6	W5,M1
Warm White	CLN6A-MKW-CJ0K0233	115	60.5	85.6	M2,M3
Warm White	CLN6A-MKW-CJ0K0513	115	60.5	85.6	W5,M1
Warm White	CLN6A-MKW-CH0L0513	115	51.0	101.8	W5,M1
Warm White	CLN6A-MKW-CJ0L0513	115	60.5	101.8	W5,M1

Notes:

1. The above kit numbers represent order codes that include multiple intensity-bin and color-bin codes. Only one intensity-bin code and one color-bin code will be shipped on each bulk. Single intensity-bin code and single color-bin codes will not be orderable.
2. Please refer to the "Cree LED Lamp Reliability Test Standards" document for reliability test conditions.
3. Please refer to the "Cree LED Lamp Soldering & Handling" document for information about how to use this LED product safely.

GRAPHS

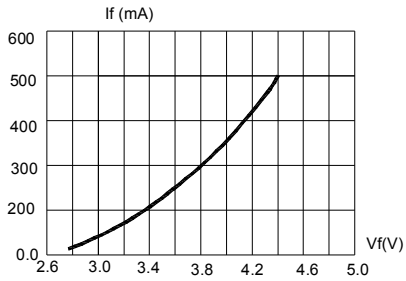

FIG.1 FORWARD CURRENT VS. FORWARD VOLTAGE.

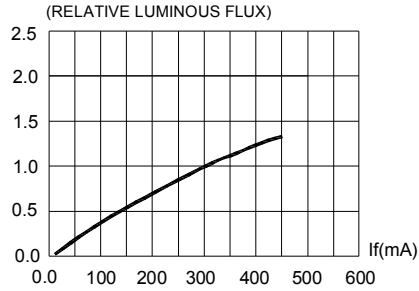

FIG.2 RELATIVE LUMINOUS FLUX VS. FORWARD CURRENT

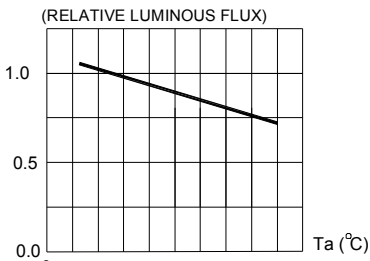

FIG.3 RELATIVE LUMINOUS FLUX VS AMBIENT TEMPERATURE DERATING BASED ON $T_{jmax}=125^{\circ}C$

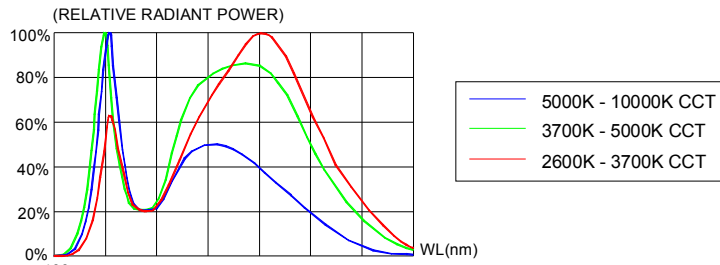

FIG.4 RELATIVE SPECTRAL POWER DISTRIBUTION

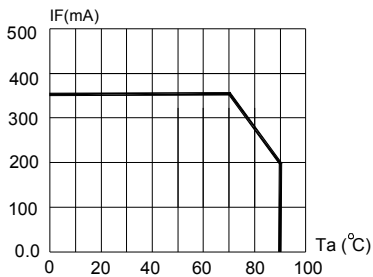

FIG.5 MAXIMUM FORWARD DC CURRENT VS AMBIENT TEMPERATURE. DERATING BASED ON $T_{jmax}=125^{\circ}C$

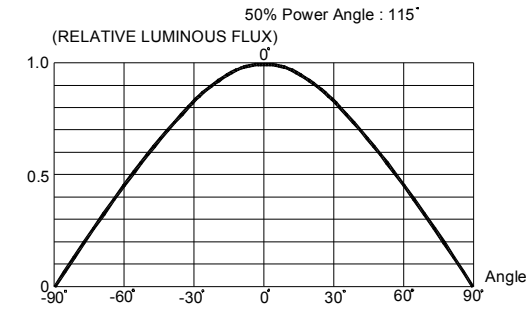
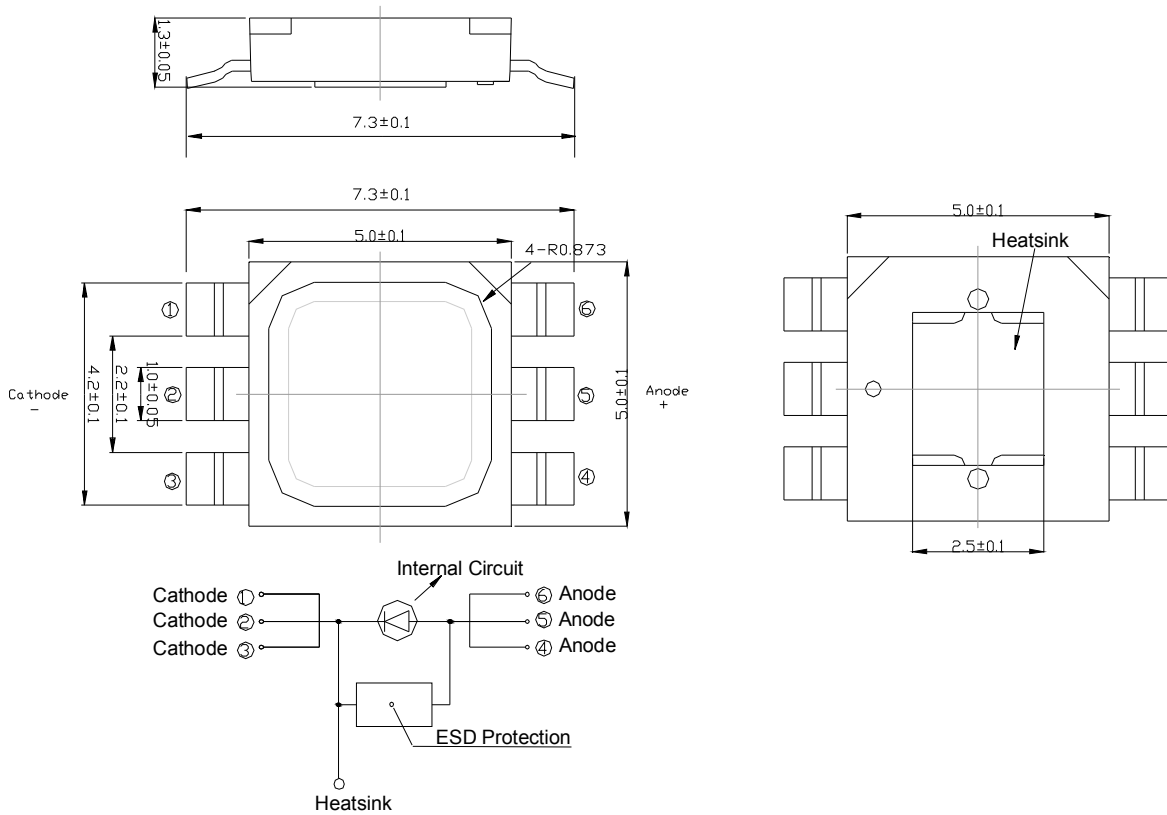

FIG.6 FAR FIELD PATTERN

The above data are collected from statistical figures that do not necessarily correspond to the actual parameters of each single LED. Hence, these data will be changed without further notice.

MECHANICAL DIMENSIONS

All dimensions are in mm.



NOTES

RoHS Compliance

The levels of environmentally sensitive, persistent biologically toxic (PBT), persistent organic pollutants (POP), or otherwise restricted materials in this product are below the maximum concentration values (also referred to as the threshold limits) permitted for such substances, or are used in an exempted application, in accordance with EU Directive 2002/95/EC on the restriction of the use of certain hazardous substances in electrical and electronic equipment (RoHS), as amended through April 21, 2006.

Vision Advisory Claim

Users should be cautioned not to stare at the light of this LED product. The bright light can damage the eye.

KIT NUMBER SYSTEM

Cree LED lamps are tested and sorted into performance bins. A bin is specified by ranges of color, forward voltage, and brightness. Sorted LEDs are packaged for shipping in various convenient options. Please refer to the "Cree LED Lamp Packaging Standard" document for more information about shipping and packaging options.

Cree LEDs are sold by order codes in combinations of bins called kits. Order codes are configured in the following manner:

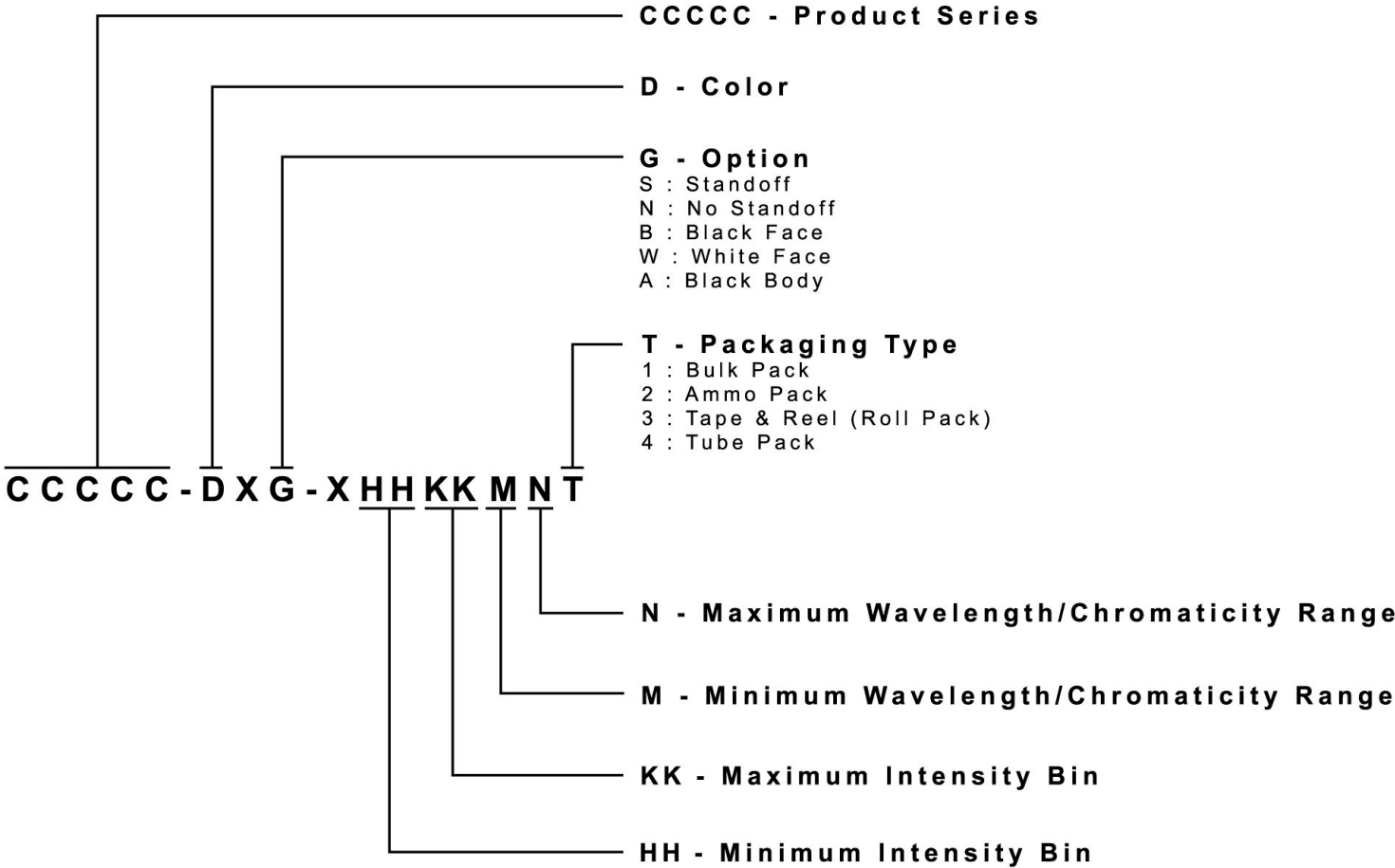

RELIABILITY

Tests and Results

Test	Applicable Standards	Test Condition	Note	Number of Damaged
Temperature Cycle*	JEITA ED-4701 100 105	-40°C~25°C~100°C~25°C 30 mins, 5 mins, 30 mins, 5 mins	100 cycles	0/50
Thermal Shock*	MIL-STD-202G	-40°C~100°C 30 mins, 30 mins	100 cycles	0/50
Moisture Resistance	JEITA ED-4701 200 203	25°C~65°C~ 90%RH 24hrs/1cycle	10 cycles	0/25
High Temperature Storage	JEITA ED-4701 200 201	T _A =100°C	1000 hrs	0/25
Temperature Humidity Storage	JEITA ED-4701 100 103	T _A =60°C RH=90%	1000 hrs	0/25
Low Temperature Storage	JEITA ED-4701 200 202	T _A =-40°C	1000 hrs	0/25
High Temperature Life Test*	-	T _A =85°C I _F =160 mA	1000 hrs	0/25
Life Test*	-	T _A =25°C I _F =350 mA	1000 hrs	0/25
High Humidity Heat Life Test*	-	60°C RH=90% I _F =250 mA	500 hrs	0/25
Low Temperature Life Test	-	T _a =-30°C I _F =300 mA	1000 hrs	0/25
Resistance to Soldering Heat(Reflow Soldering)*	JEITA ED-4701 300 301	T _{sol} =260(±5)°C,10sec (Pre treatment 30°C,70%,168hrs)	2 times	0/25
Solder ability (Reflow Soldering)	JEITA ED-4701 300 303	T _{SOL} =215±5°C, 3 sec (Lead Solder)	1 time (over 95%)	0/25
Vibration-variable Frequency	MIL-STE-883 Method 2007	20G min, 20 to 2000Hz, 4cycles, 4mins, Each x,y,z	16 mins	0/25
Substrate Bending	JEITA ED-4702	3mm, 5±1 sec	1 time	0/25
Adhesion Strength	JEITA ED-4702	5N, 10±1 sec	1 time	0/25
Electrostatic Discharge Test	MIL-STD-883 Method 2007	Human body model 1000 V	+/-1 time	0/25

Items marked with * are selective.

Failure Criteria

Item	Symbol	Test Condition	Criteria for Judgment	
			Min.	Max.
Forward Voltage	V _F	I _F = 300 mA	-	Initial Data x 1.1
Reverse Current	I _R	V _R = 5 V	-	100 μA
Luminous Flux/Intensity	Φ _V	I _F = 300 mA	Initial Data x 0.7	
Resistance to Soldering Heat	-	I _F = 300 mA	No dead lamps and visual damage	
Vibration-variable Frequency	-	I _F = 300 mA	No dead lamps and visual damage	

SOLDERING & HANDLING

1. Cleaning

- Don't use unspecified chemical liquids to clean the SMD LED; the chemical could harm the SMD LED. When washing is necessary, please immerse the SMD LED in alcohol at normal room temperature for less than 1 minute and dry at normal room temperature for 15 minutes before use.
- The influence of ultrasonic cleaning on the SMD LED depending on factors such as ultrasonic power and the way SMD LED are mounted. Ultrasonic cleaning shall be pre-qualified to ensure this will not cause damage to the SMD LED.

2. Moisture Proof Packing

- In order to prevent moisture absorption into SMD LED during the transportation and storage, SMD LED is packed in a moisture barrier bag. Desiccants and a humidity indicator are packed together with SMD LED as the secondary protection. The indication of humidity indicator card provides the information of humidity within SMD packing.

3. Storage

- Shelf life in original sealed bag at storage condition of $<40^{\circ}\text{C}$ and $<90\%RH$ is 12 months. Baking is required whenever shelf life is expired.
- Before opening the packaging, Please check whether bag leak air or not.
- After bag opening, the SMD LED must be stored under the condition $<30^{\circ}\text{C}$ and $<60\%RH$. Under this condition, SMD LED must be used (subject to reflow) within 168 hours after bag opening, and re-baking is required when exceeding 168 hours.
- For baking, place SMD LED in oven at temperature $80^{\circ}\text{C}\pm 5^{\circ}\text{C}$ and relative humidity $\leq 10\%RH$, for 24 hours.
- Take out the material from packaging bag for re-bake. Do not open the door of oven frequently during the baking process.

4. Soldering

- Manual soldering by soldering iron
- The use of a soldering iron of less than 25W is recommended and the temperature of the iron must be kept at below 315°C , with soldering time within 2 seconds.
- The epoxy resin of SMD LED should not be in contact with tip of soldering iron.
- No mechanical stress should be exerted on the resin portion of SMD LED during soldering.
- Handling of SMD LED should be done when the package has been cooled down to below 40°C or less. This is to prevent the SMD LED failures due to thermal-mechanical stress during handling.
- Reflow Soldering
- The temperature (Top surface of SMD LED) profile is as below:

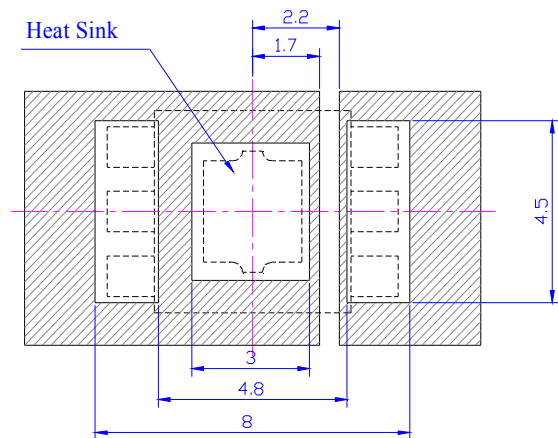
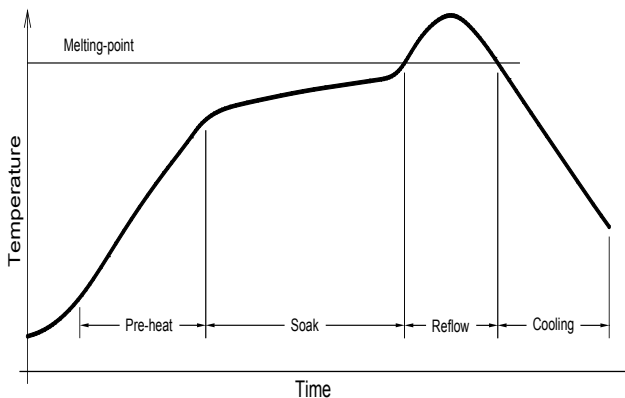

Solder = Lead-free

Average ramp-up rate = 4°C/s max	Peak temperature = 250°C max.
Preheat temperature = $150^{\circ}\text{C} \sim 200^{\circ}\text{C}$	Time within 5°C of actual Peak Temperature = 10s max.
Preheat time = 100s max.	Duration above 217°C is 80s max.
Ramp-down rate = 6°C/s max.	

PACKAGING

- The boxes are not water resistant and they must be kept away from water and moisture.
- The LEDs are packed in cardboard boxes after packaging in normal or anti-electrostatic bags.
- Cardboard boxes will be used to protect the LEDs from mechanical shocks during transportation.
- The reel pack is applied in SMD LED.
- Max 1100 pcs per reel.

